

Concealed single-lever mixer with diverter - Brushed Platinum













TARA

36 120 660



- automatic diverter
- cover plate Ø 150 mm

Fits: TARA, META

	Brushed Platinum	36 120 660-06
	Chrome	36 120 660-00
	Platinum	36 120 660-08
	Dark Chrome	36 120 660-19
	Light Gold	36 120 660-26
	Brushed Light Gold	36 120 660-27
	Brushed Durabrass (23kt Gold)	36 120 660-28
	Matte Black	36 120 660-33
	Brushed Bronze	36 120 660-42
	Brushed Champagne (22kt Gold)	36 120 660-46
	Champagne (22kt Gold)	36 120 660-47
	Brushed Chrome	36 120 660-93
	Brushed Dark Platinum	36 120 660-99

Required miscellaneous



Concealed single-lever mixer with backflow preventor - 35 021 970 90
 •max. recess depth 105 mm
 •min. recess depth 80 mm

Recommended miscellaneous



xGRID Attachment set for integrating in the dry wall construction - 12 340 970 90

Required miscellaneous



Concealed single-lever mixer - 35 020 970 90
 •max. recess depth 105 mm
 •min. recess depth 80 mm

Required miscellaneous



xGRID Installation track 555 mm - 12 360 970 90

36 120 660

mm [inches]

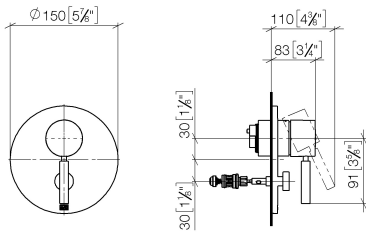

Flow rate chart

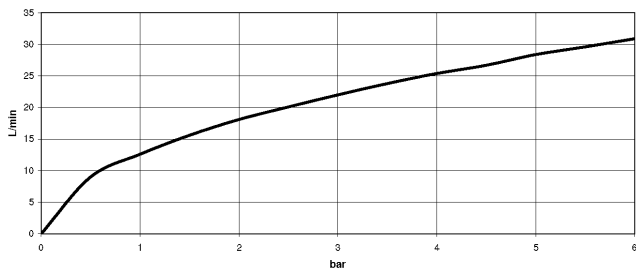

Certificates

DVGW_DW-
6512DN0126.

LGA_19863.

WRAS_2207012.

36 120 660

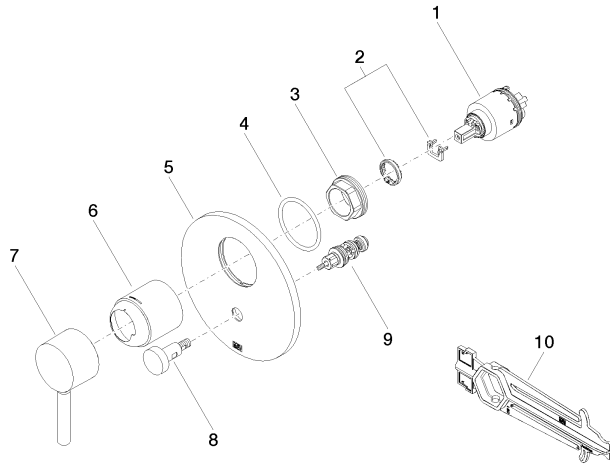

Spare parts list

No.	Item Number	Name	Quantity used	Delivery time
1	90 15 05 038 00 90	cartridge	1	60
2	04 28 10 149 00 90	accessories	1	2
3	09 24 04 448 90	nut	1	2
4	09 14 10 084 90	seal	1	2
5	09 11 02 261-06	plate	1	10
6	09 11 02 260-06	sleeve	1	10
7	90 20 66 004 00-06	handle	1	10
8	90 31 09 139 00-06	pull-rod	1	10
9	90 21 34 081 00 90	diverter	1	2
10	90 30 09 064 00 90	key	1	2